

Guia Rápido Pinagens ATMEL

AT MEGA 8

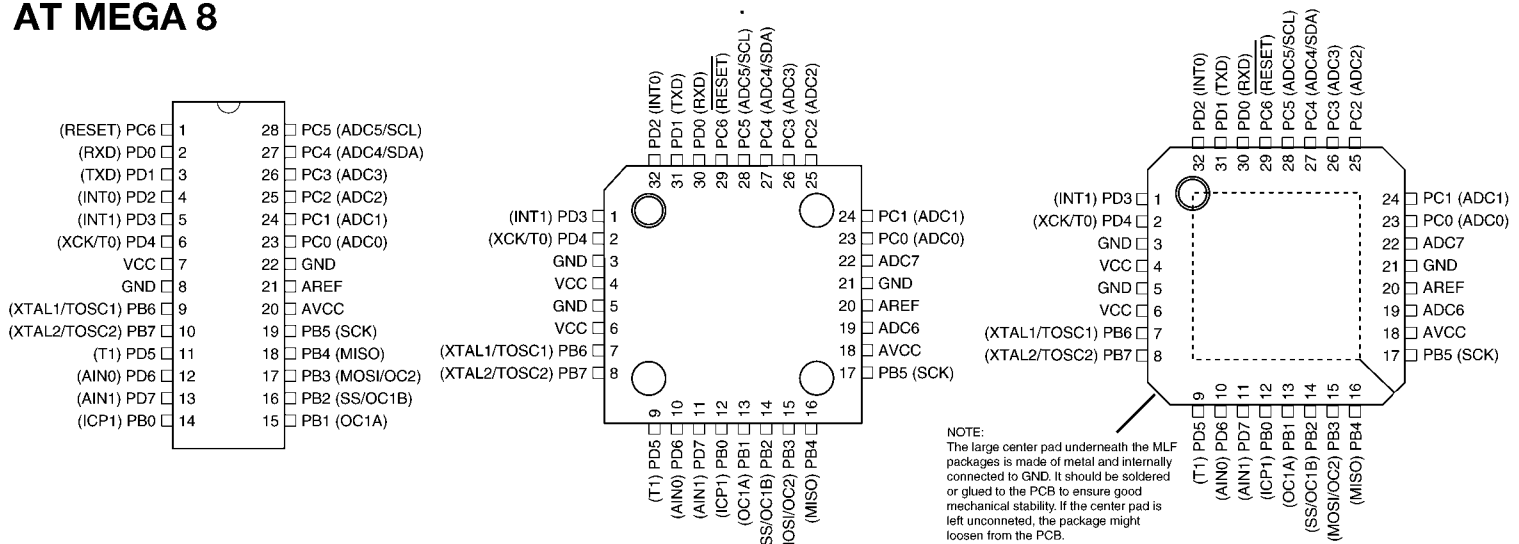

AT MEGA 16

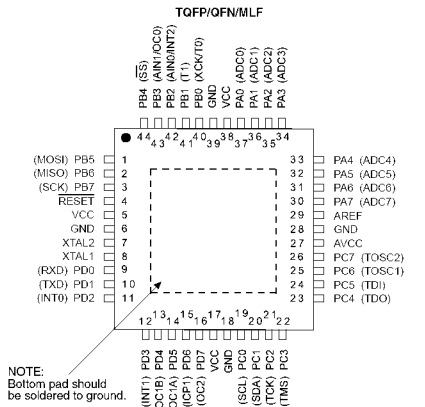
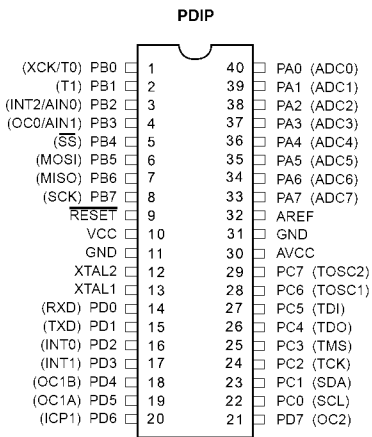

AT 90s2313

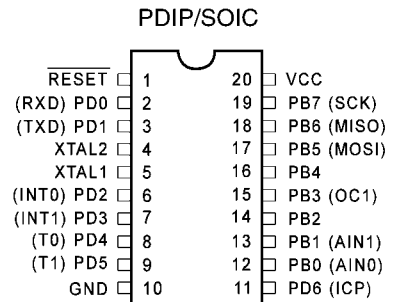

AT MEGA 128

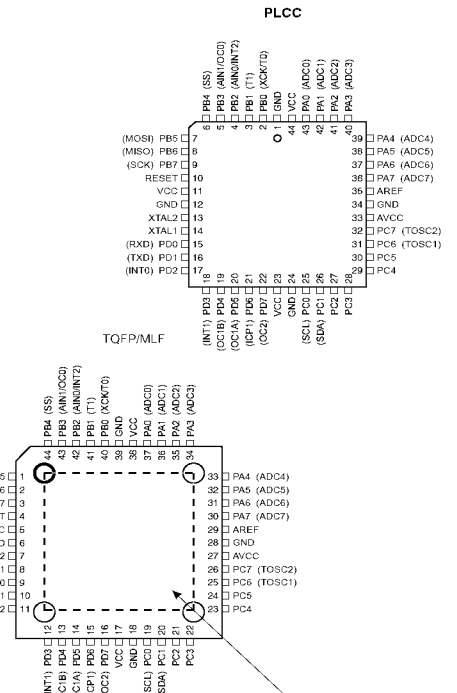
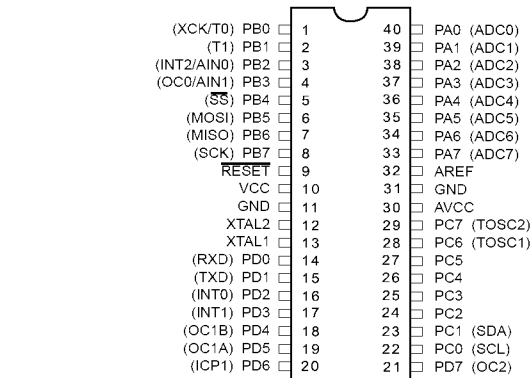
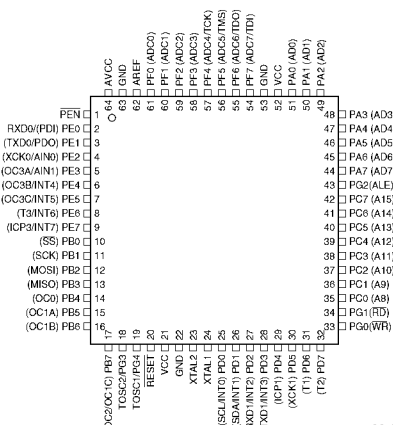

AVR ISP connectors

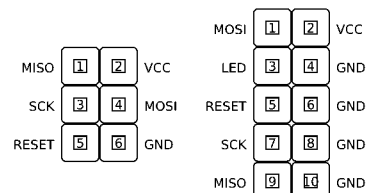

NOTE: MLF Bottom pad should be soldered to ground.